



SSV WORKS, 4610 Calle Quetzal, Camarillo, CA 93012
www.SSVworks.com | Phone: 818-991-1778 | Fax: 866-293-6751

X32-PHZ4V

2017-2023 Can Am Maverick X3
Phase-4, V-Spec, 5-Speaker
1650 Watt Audio Kit
with JVC MR3



Maverick X3

pg 8
Panel
Disassembly



pg 10
Dash Speaker Panel
Installation



pg 10
RGB Controller Command Center
Installation



pg 13
Amp Plate
Installation



pg 17
JVC MR1
Installation



pg 20
Subwoofer
Installation



pg 22
RGB Cage Mount Speakers
Installation





SSV WORKS, 4610 Calle Quetzal, Camarillo, CA 93012
 www.SSVworks.com | Phone: 818-991-1778 | Fax: 866-293-6751

PARTS LIST 1/7

Amp/Wiring Installation

WARRANTY INFORMATION:

All SSV Works enclosures are covered by a limited lifetime warranty against defects in material or workmanship. All SSV Works Electronics are covered by a limited 1 year warranty against defects in material or workmanship. All SSV Works Speakers are covered by a limited 1 year warranty against defects in material or workmanship. Labor for replacement of defective components is not covered. Contact SSV Works for further warranty information.



Please read and understand these instructions completely before installation to avoid possible injury, or damage to the accessory or vehicle.

TOOLS NEEDED FOR INSTALLATION

- | | | |
|--------------------------|-------------------------------|-------------------|
| - T30 torx | - 18 mm socket with extension | - #2 screw driver |
| - 10mm wrench or ratchet | - Wire crimpers | - #3 screw driver |
| - 13mm wrench or ratchet | - Panel removal tool | |

PARTS LIST IMAGES



Amp Tray with pre-loaded Kicker 400.4 & 600.1 Amps



Amp Power Wire x2 (A-H1Q)



Front RGB Harness (B-H2935)



Front Speaker Harness (B-H1385)



RCA Patch Cable, Male to Male (B-X3-HRCA)



2-Pin Sub Extension (B-H2702)



RGB Extension Harness, 2 ft. (B-H2934)



2-Pin to Male RCA (B-H3543)



Audio Extension Harness 8ft. (B-H1913)



Audio Extension Harness 2ft. (B-H1912)



RGB Extension Harness 8 ft (B-H2933)



Fuse Holder with 40A Fuse x 2



Battery Terminal Cable x2



Zip Ties x 10



SSV WORKS, 4610 Calle Quetzal, Camarillo, CA 93012
www.SSVworks.com | Phone: 818-991-1778 | Fax: 866-293-6751

Dash Kit

WARRANTY INFORMATION:

All SSV Works enclosures are covered by a limited lifetime warranty against defects in material or workmanship. All SSV Works Electronics are covered by a limited 1 year warranty against defects in material or workmanship. Labor for replacement of defective components is not covered. Contact SSV Works for further warranty information.



Please read and understand these instructions completely before installation to avoid possible injury, or damage to the accessory or vehicle.

TOOLS NEEDED FOR INSTALLATION

- T25, T30, T40 torx driver
- #2 Phillips screwdriver
- Air saw and safety equipment
- Drill and 1/8" and 1/4" drill bit

PARTS LIST IMAGES



1. JVC MR1 Headunit

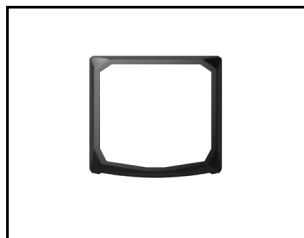

2. MR1 Trim Ring



3. DMR1 Dash Kit x1



4. DMR1 Base Plate x1



4. MR1 dash screws x2



5. M6 x 1.0 Screws, Nuts & Washers x4 (T-30 torx)



7. Push Pins x2



8. Drill Guides x4



JVC MR1 to SSV Adapter Harness (B-H2368)

INSTALLATION NOTES

Always disconnect battery. For instructions regarding the headunit, refer to the JVC manual.



SSV WORKS, 4610 Calle Quetzal, Camarillo, CA 93012
www.SSVworks.com | Phone: 818-991-1778 | Fax: 866-293-6751

RGB LED Controller Command Center

WARRANTY INFORMATION:

All SSV Works enclosures are covered by a limited lifetime warranty against defects in material or workmanship. All SSV Works Electronics are covered by a limited 1 year warranty against defects in material or workmanship. Labor for replacement of defective components is not covered. Contact SSV Works for further warranty information.



Please read and understand these instructions completely before installation to avoid possible injury, or damage to the accessory or vehicle.

TOOLS NEEDED FOR INSTALLATION

- Cutter



LIT-CC, 3 Output RGB LED Controller Command Center



LIT-CC, RGB LED Controller Rocker Switch



Power Pigtail

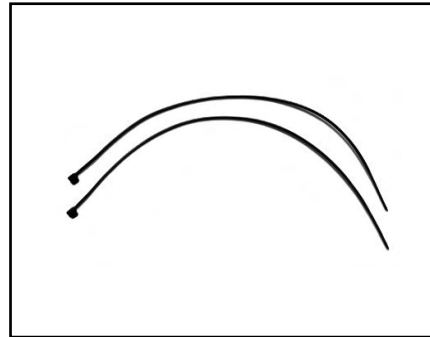

Zip Ties (x2)

Included Universal Controller Pigtails are NOT used in this installation.





SSV WORKS, 4610 Calle Quetzal, Camarillo, CA 93012
www.SSVworks.com | Phone: 818-991-1778 | Fax: 866-293-6751

PARTS LIST 4/7

6.5" Dash Speaker Panels

WARRANTY INFORMATION:

All SSV Works enclosures are covered by a limited lifetime warranty against defects in material or workmanship. All SSV Works Electronics are covered by a limited 1 year warranty against defects in material or workmanship. Labor for replacement of defective components is not covered. Contact SSV Works for further warranty information.



Please read and understand these instructions completely before installation to avoid possible injury, or damage to the accessory or vehicle.

TOOLS NEEDED FOR INSTALLATION

- T20 & T30 Torx Driver

- 8, 10 & 13mm Socket Wrench



Speaker Panel, Drive Side



Speaker Panel, Passenger Side



Vibration Dampening Loop Clamp



Hardware Pack [B-HP3551]



Smart-Lok Module Relocation Bracket [B-MB3546]



SSV WORKS, 4610 Calle Quetzal, Camarillo, CA 93012
 www.SSVworks.com | Phone: 818-991-1778 | Fax: 866-293-6751

PARTS LIST 5/7

10" Driver Side Under Seat Subwoofer Enclosure

WARRANTY INFORMATION:

All SSV Works enclosures are covered by a limited lifetime warranty against defects in material or workmanship. All SSV Works Electronics are covered by a limited 1 year warranty against defects in material or workmanship. Labor for replacement of defective components is not covered. Contact SSV Works for further warranty information.



Please read and understand these instructions completely before installation to avoid possible injury, or damage to the accessory or vehicle.

TOOLS NEEDED FOR INSTALLATION

- 10mm, 13mm, 16mm and 18mm Sockets & Wrenches

- T-30 & T-40 Torx Driver

- 1½" Hole Saw

- Hole Punch / Scribe Tool

- Ratchet & Extension

- #3 Phillips Screwdriver

PARTS LIST IMAGES



1. X32-DUS10 Enclosure



2. M6 x 16mm Screws & Washers x 10 (T-30 torx)

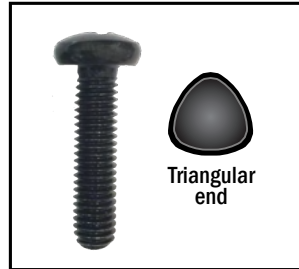

3. Thread Rolling Screw x 2



4. M6 x 25mm Screw x 1



5. Large washers x 2



6. C-Bracket



7. A-Bracket x 1



8. Large Bracket



9. Seat Spacer x 1



10. Small Spacer x 1



11. M6 Locking Hex Nut

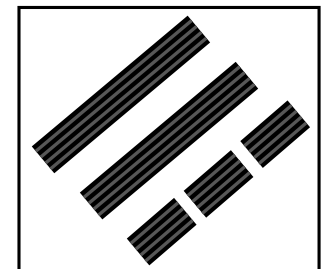

12. Foam Strips x 5



SSV WORKS, 4610 Calle Quetzal, Camarillo, CA 93012
www.SSVworks.com | Phone: 818-991-1778 | Fax: 866-293-6751

PARTS LIST 7/7

6.5" RGB Cage Mount Speaker Enclosures

WARRANTY INFORMATION:

All SSV Works enclosures are covered by a limited lifetime warranty against defects in material or workmanship. All SSV Works Electronics are covered by a limited 1 year warranty against defects in material or workmanship. All SSV Works Speakers are covered by a limited 1 year warranty against defects in material or workmanship. Labor for replacement of defective components is not covered. Contact SSV Works for further warranty information.



Please read and understand these instructions completely before installation to avoid possible injury, or damage to the accessory or vehicle.

Placement of the pod depends on what type of roll cage you have (factory or aftermarket) and your preference of where you want the pods to be installed. In these instructions, we have installed them on the outside vertical bars at the back of the roll cage.

TOOLS NEEDED FOR INSTALLATION

- 5mm Allen Key
- 8mm Open End Wrench

PARTS LIST IMAGES



US2-C65 6.5" V Speakers with RGB Cage Mount Pods



Dual Mounting Ring Adapter (x2)



Ring Clamp (x4)

INCLUDES 1.85" CLAMP - AFTERMARKET ROLL CAGE MAY REQUIRE A DIFFERENT CLAMP SIZE



M6 Hex Head Bolts & Washers (x4)



M6 Allen Socket Head Bolts & Washers (x4)



M6 Set Screws (x4)



Rear Speaker "Y" Harness

INSTALLATION NOTES

It is recommended to wrap the bag that the clamps come in around the cage before you slide the clamp onto the cage to prevent scratching.

PANELS AND DASH DISASSEMBLY

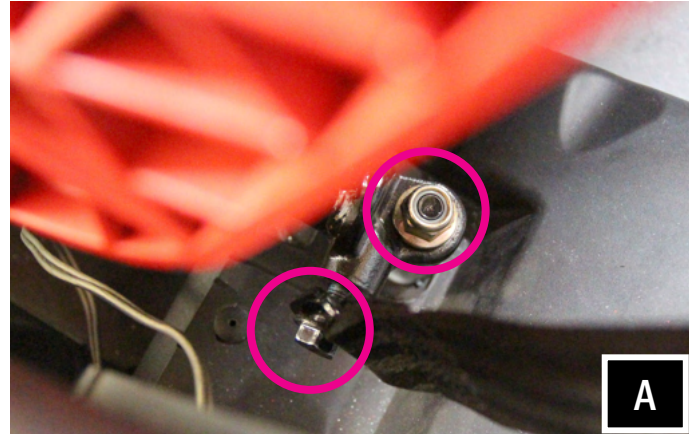

A. To remove the seat, use a 13mm socket and wrench to remove front (2) bolt and nut, and use a 18mm socket to remove (2) rear nuts and seat belt nut (repeat on other seat)

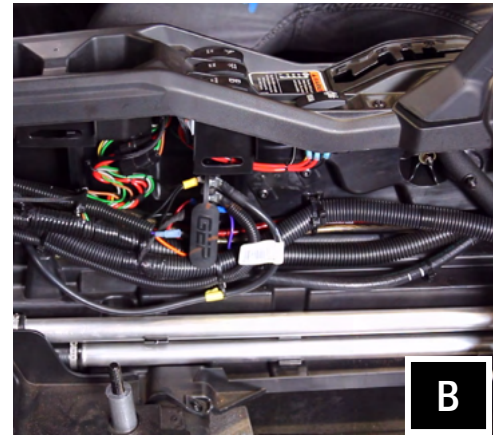
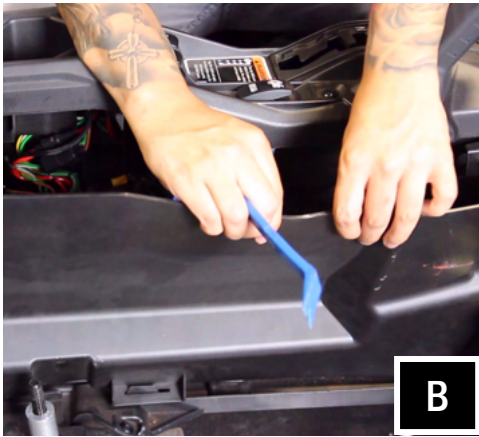

B. Carefully unsnap console panels by hand or with a panel removal tool.

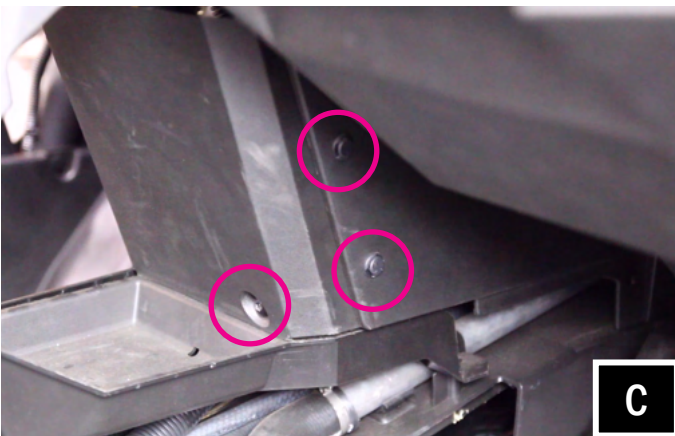

C. Unscrew (2) T30 torx located on the center console panel under the dash. Use a panel tool to remove push pins on passenger side.



D. Carefully unsnap rear cover to expose the engine compartment

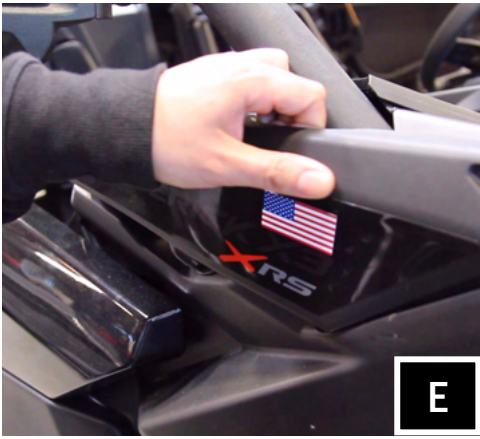

E. Remove gas cover on the passenger side to expose a 10mm nut. Unscrew with a wrench and T30 torx driver.

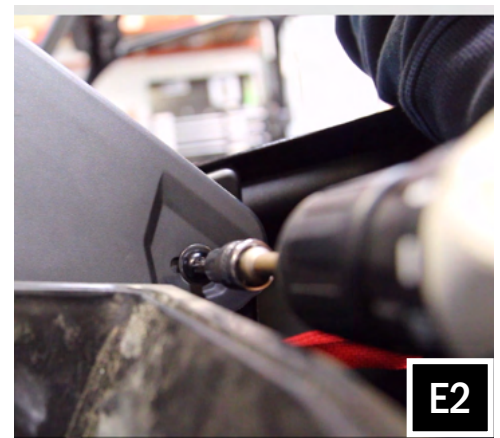
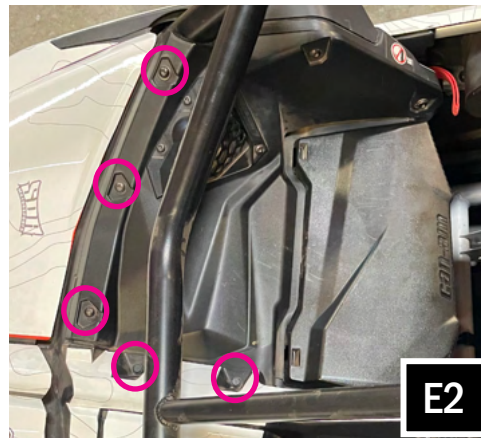
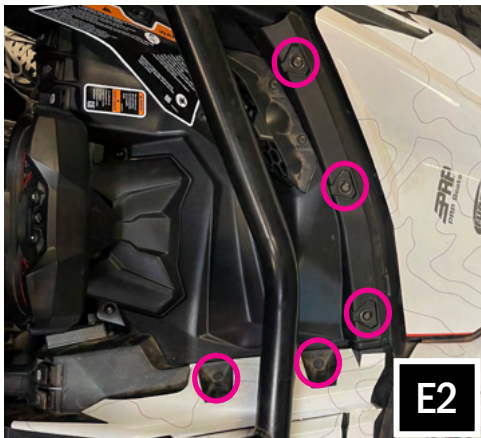

E2. Using panel removal tool unclip (2) push clips on the driver and passenger side dash covers. Unscrew the (4) T30 screws on the passenger side, and (7) T30 screws on the driver side.

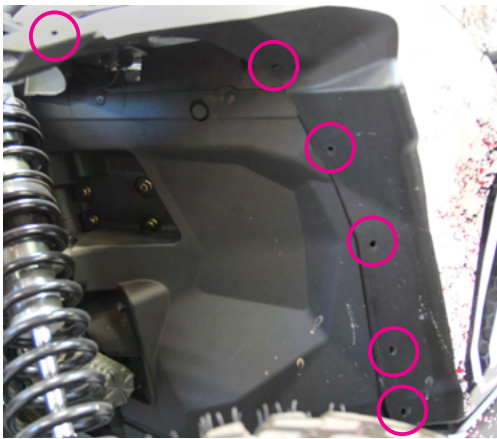

F. Remove fender well panel using a T30 driver (will need a 10mm socket for the screw near the headlight)

G. After the fender well panel is removed, remove the third fastener clip from the bottom.

DASH SPEAKER PANEL INSTALLATION

TOOLS NEEDED FOR INSTALLATION

- T20 & T30 Torx Driver

- 8, 10 & 13mm Socket Wrench



NOTE: Refer to the X3-DP65V installation manual included in the kit for a detailed installation process of the dash speaker panels.

RGB LED CONTROLLER COMMAND CENTER INSTALLATION

TOOLS NEEDED FOR INSTALLATION

- Wire Cutter

- Wire Stripper

- Crimper

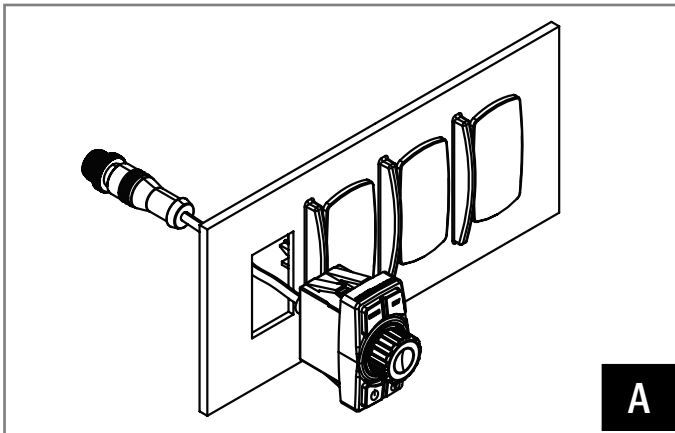

A. Install the LIT-CC RGB LED Controller Rocker Switch in an unoccupied rocker switch opening.

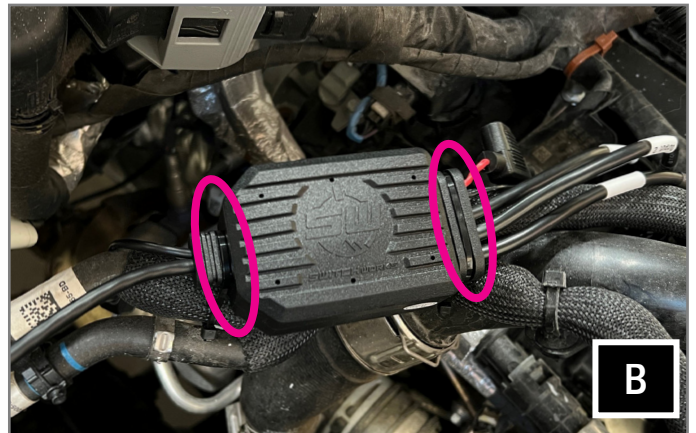

B. Mount the LIT-CC RGB LED Controller Command Center in the dash away from moving parts and secure with zip ties. Cut excess zip ties for a clean install.

NOTE: Refer to the 230-LIT-CC User Guide for detailed operation instructions.

RUNNING WIRE HARNESES

AMP POWER CABLES

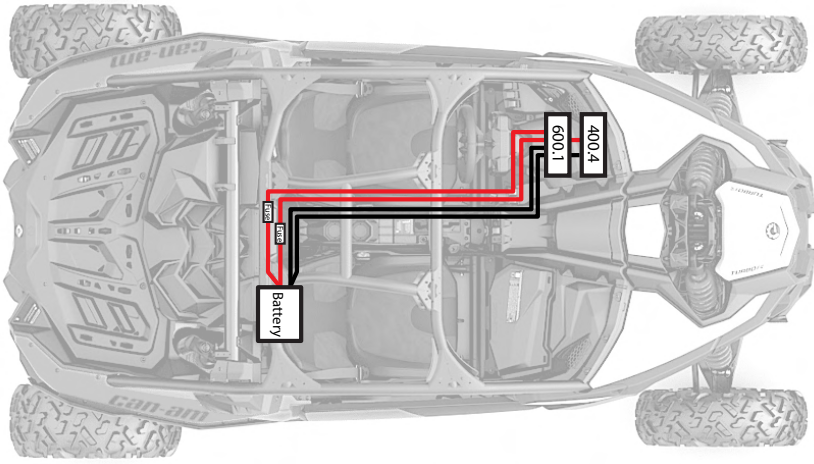

Connect the A-H1Q (x2) power/ground wire from the amplifiers to the battery. Use the provided fuse holder for circuit protection.

JVC MR1 POWER HARNESS

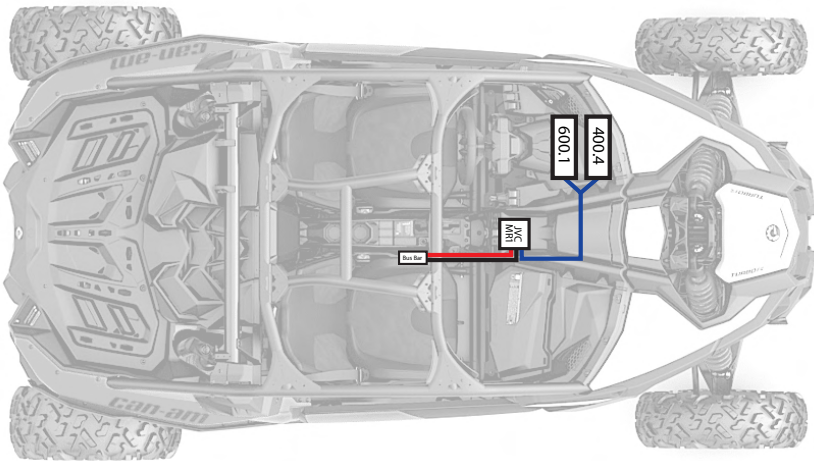

Connect the SSV to JVC MR1 adapter harness (B-H2368) power and ground wires to the factory bus bar located in the center console beside the passenger seat. Connect the blue amp turn on wire to the amplifiers.

SUBWOOFER AUDIO CABLES

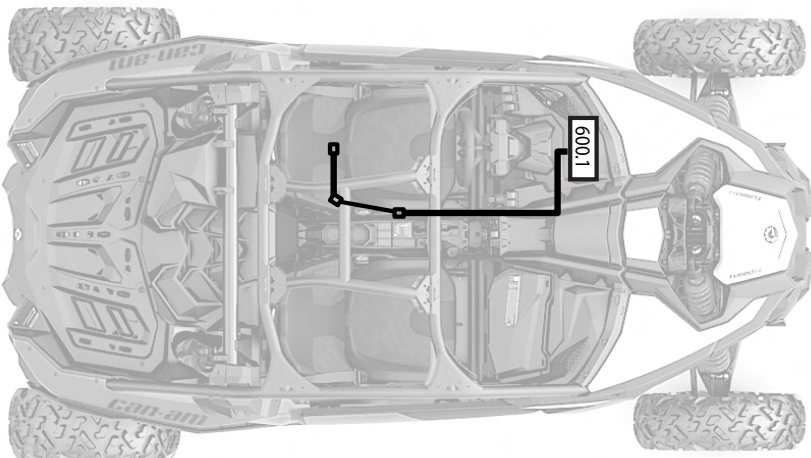

Run the A-H2702K Subwoofer extension cable from 600.1 amplifier to the subwoofer.

DASH SPEAKER PANEL AUDIO CABLES

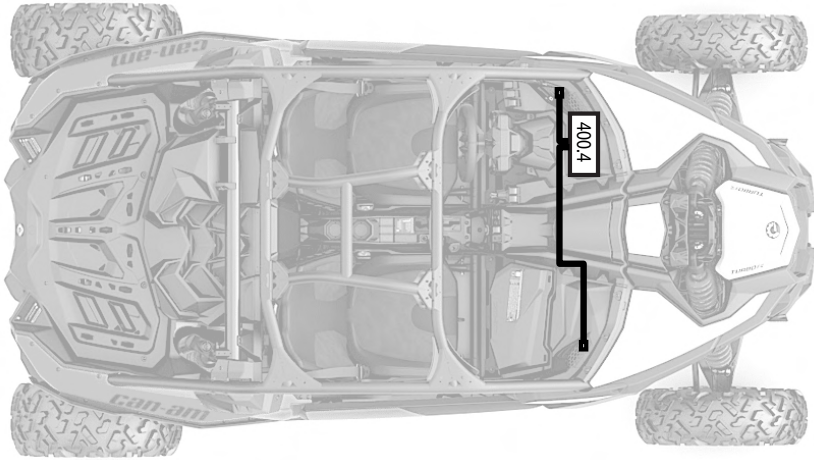

Run the B-H1385 front speaker harness from 400.4 amplifier to the dash speaker panels. The shorter end of the harness goes to the driver side dash speaker panel.

REAR CAGE POD SPEAKER AUDIO CABLES

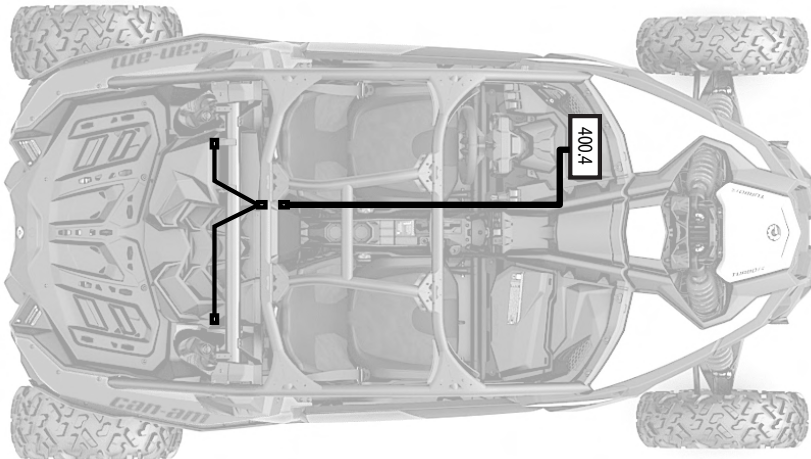

Run the B-H1913 & B-H1912 4-pin audio extension harness from the 400.4 amplifier rear output to the B-H2195 rear speaker harness.

LIT-CC RGB CONTROLLER WIRING

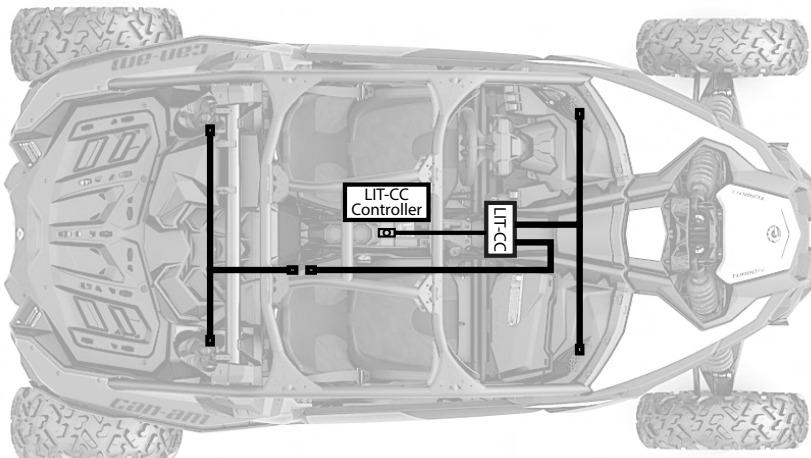

Run the B-H2934 (2 ft) RGB extension harness to the B-H2965 Front RGB harness from the LIT-CC output to the dash speaker panels. Run the B-H2933 (8 ft) RGB extension harness to the B-H3519 RGB rear speaker harness. Mount the LIT-CC Controller in an empty rocker switch slot and route the cable to the LIT-CC RGB Controller.

AMP WIRING

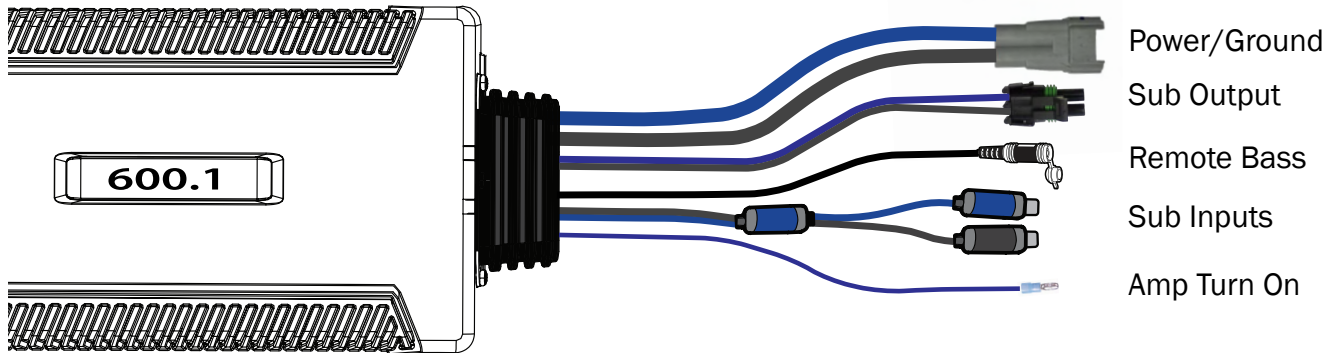
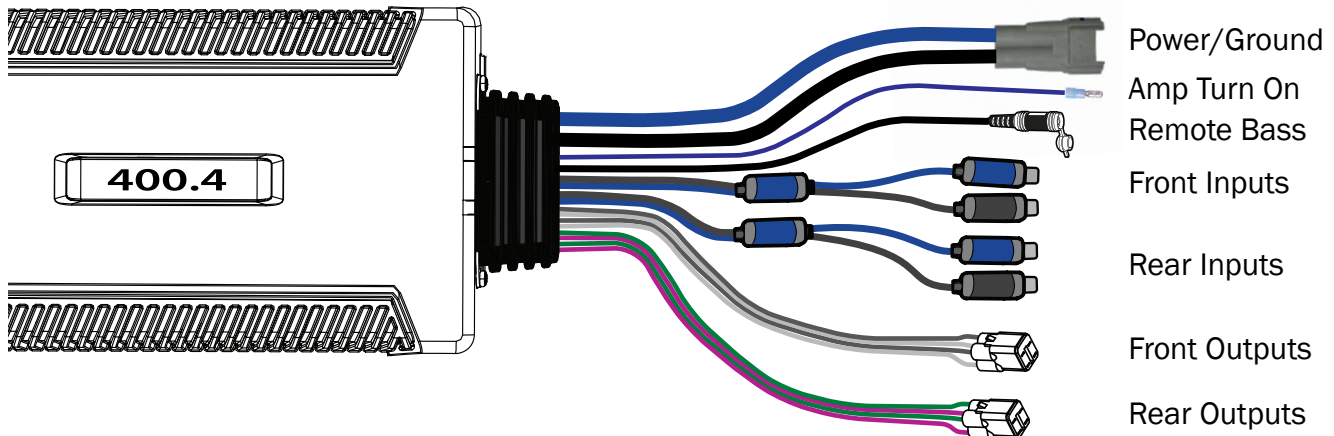

AMP PLATE INSTALLATION

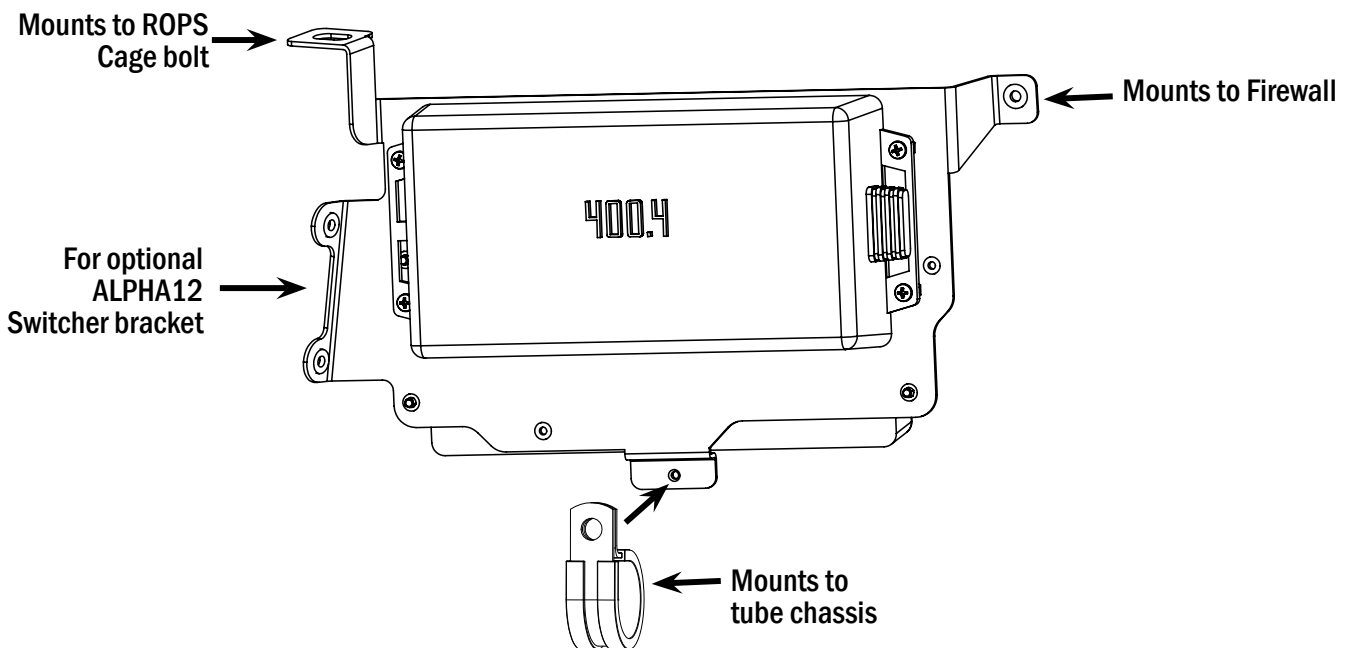



The amp tray mounts on the driver side firewall above the tube chassis.



A. Make a pilot hole with a pick tool through the top right screw hole in the amp plate and push all the way through the vehicle panel.



B. Drill a hole through the pilot holes using a 1/4" drill bit. Be sure to move the amp plate out of the way before drilling.



C. Secure the amp tray to the vehicle's ROPS cage using the supplied M6 flange hex head Bolt, 10mm nut and washer.



D. From the outside of the firewall, use the included M6 x 16mm screw and washer to secure the amp plate through the hole you drilled on the firewall.

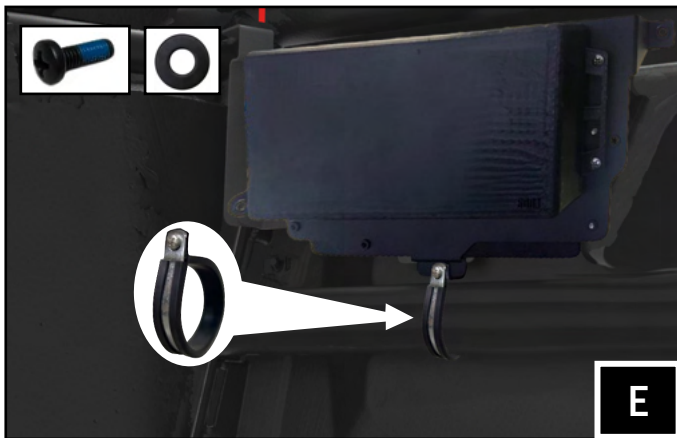

E. Mount the loop clamp to the bottom tube chassis and secure it to the amp tray using an included M4 x 12mm Phillips screw and washer.

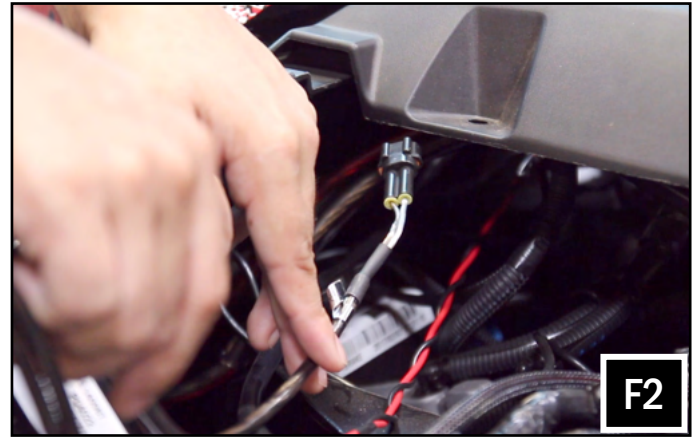

F. Route the front speaker harness (B-H1385) and RGB harness (B-H2935) towards the driver and passenger side of the vehicle and plug in the 4 pin audio connector to the 400.4 amplifier front outputs. Leave the 4 pin RGB connector at the center of the dash or LIT-CC RGB Controller mounting location.



G. Connect the subwoofer outputs of the 600.1 amplifier to the 2 pin subwoofer audio extension harness (B-H2702) (G). Connect amplifier power harnesses to 400.4 and 600.1 amplifiers (G2).

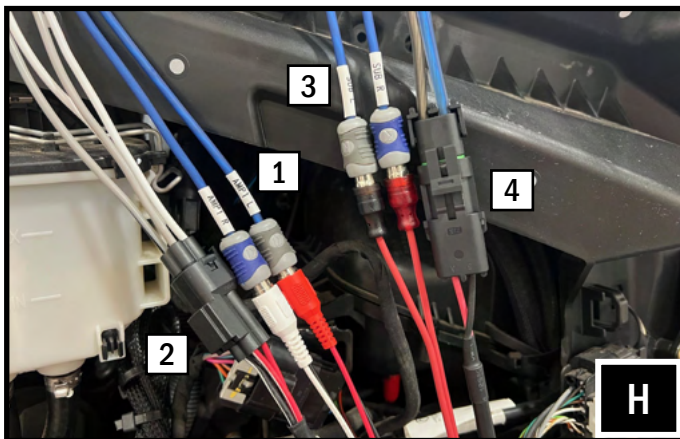

H. Audio Wiring Connections:

400.4 Amp

- [1] Input (AMP1 R/L) → B-H3543 RCAs → B-H2368 (SSV to JVC Adapter Harness) 4 Pin Front Output
- [2] Front Outputs → B-H1385 → To front speakers
- [3] Rear Outputs → B-H1913 → B-H3519 → To Rear Cage Pod Speakers

600.1 Amp

- [3] Input (SUB R/L) → B-HX3RCA (RCA Patch Cable) → JVC MR1 Sub-W Line out RCAs
- [4] Subwoofer Output → A-H2702K (2 pin Subwoofer Extension Cable) → B-H3081 (Y Splitter) → X3-DUS10 & X3-PUS10 Sub Woofers

H2. Plug in Amp turn on wires from both amps to the B-H2368 (SSV to JVC Adapter Harness) turn on wire.

RUNNING AMP POWER CABLE AND SPEAKER WIRE

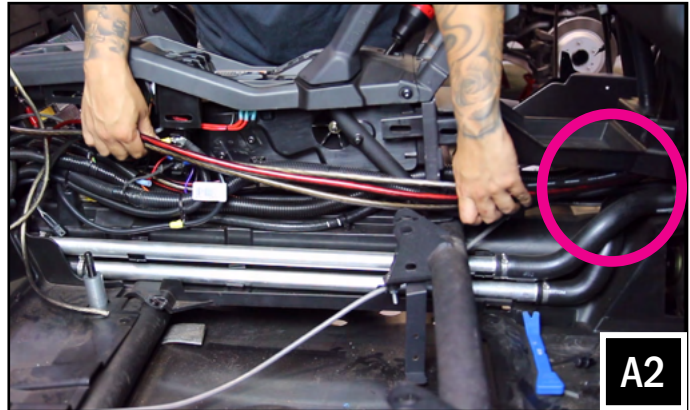
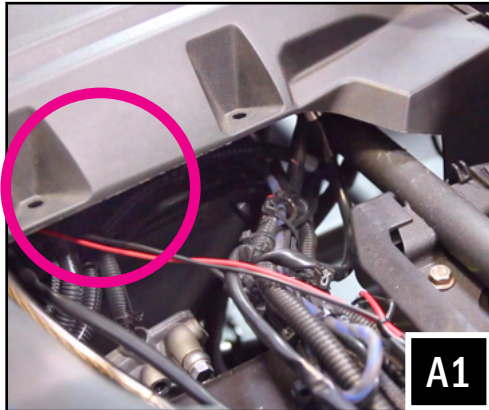

A. In this step you will be feeding all of the necessary wires from the top driver side dash down the center dash column. Be sure to run all of the wires along side the factory cabling and avoid any moving parts. Feed the amp power wire, both audio extension harnesses, (one is for subwoofer, the second is for rear cage mount speakers), RGB extension harness and power/ground for JVC MR1 from top driver side down the center column (A1). Pull all wires through the bottom center column and across the center console with the factory wiring (A2).



B. Run the second audio extension harness and RGB extension harness through the rear center console cavity, following the factory cables. These harnesses will be used for the RGB Cage Mounted Speakers.

DASH KIT ASSEMBLY

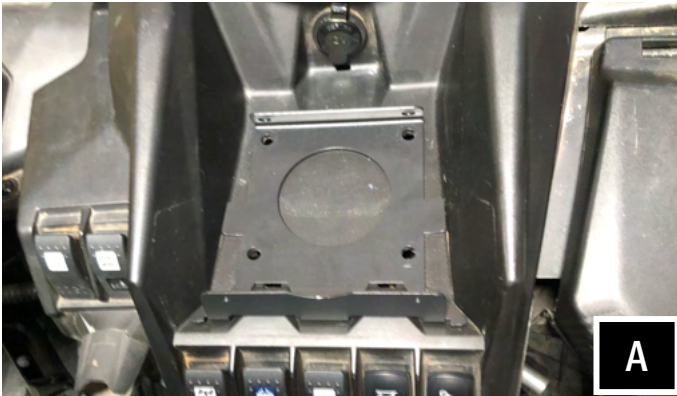

A. Set the base plate on the dash. Press the (4) drill guides onto the base plate

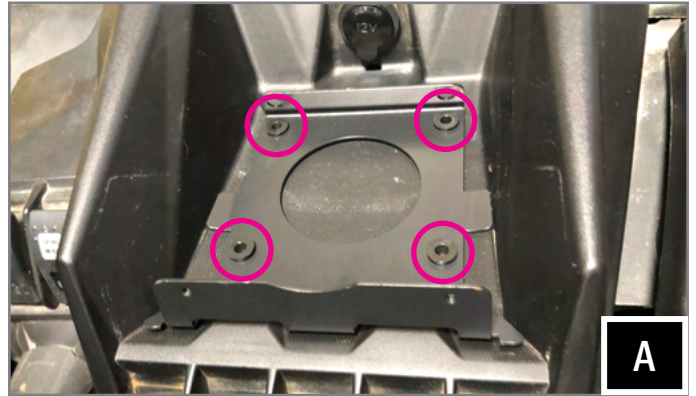

B. Using a 1/8" drill bit, drill the center of the drill guides to provide pilot holes. Limit speed and depth of the drill bit to avoid damaging any wiring.



C. Set aside the base plate and open the pilot holes up with a 1/4" drill bit.

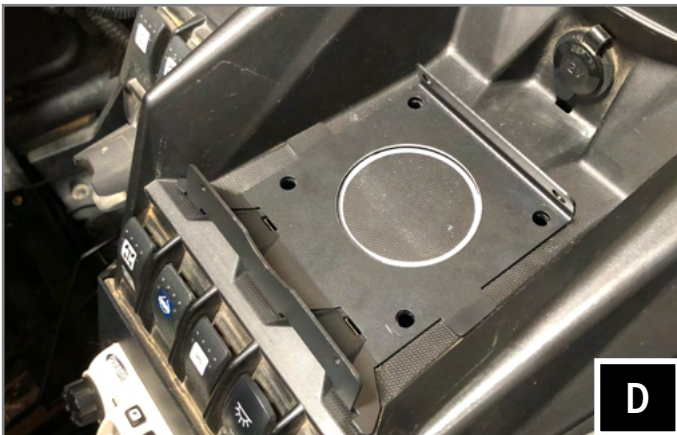

D. Reset the base plate, trace the outline of the baseplate circle.



E. Cut out the traced circle. Limit speed and depth of cutting device to avoid damaging any wiring.



F

F. Place (4) M6 T30 screws and washers into each drilled hole. Fasten from the bottom a washer and M6 nut. Secure each screw with 10mm wrench and T30 torx driver.

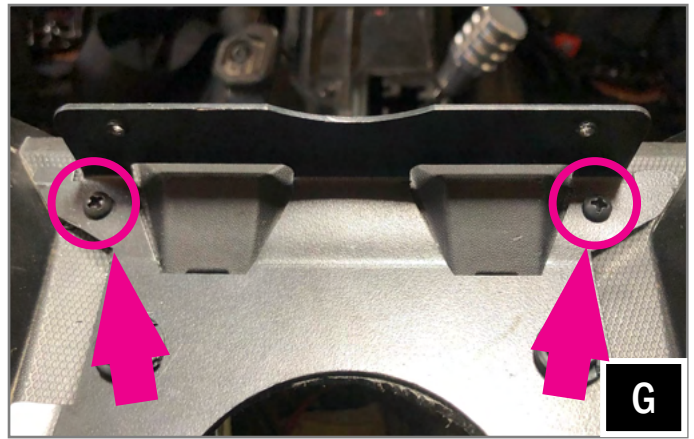

G

G. Using a #2 Phillips screwdriver, secure the front of the base plate with the provided (2) #6 x 1/2" screws.



H

H. Route the MR1 power harness and 500.1 audio input and any other related accessories out of the cutout.



I

I. Place the DMR1 over the base plate with the harness routed out of it.



J

J. Place the MR1 into the DMR1. When placing the MR1 into the dash mount, feed slack wiring back into the dash cavity cut out. This will allow for proper fitment of the MR1.



K

K. Secure the MR1 with the (4) M3.5 screws provided with the MR1. The top (2) screws will thread into the DMR1. The lower (2) screws will go through the DMR1 and into the threads of the base plate.

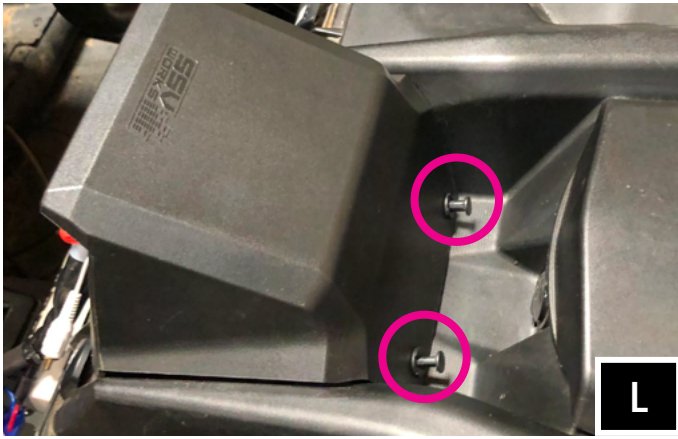

L. Secure the backside of the DMR1 with (2) push pins.



M. Center the trim ring on the MR1 and firmly press down until the side and corners click into place.

JVC MR1 WIRING CONNECTION

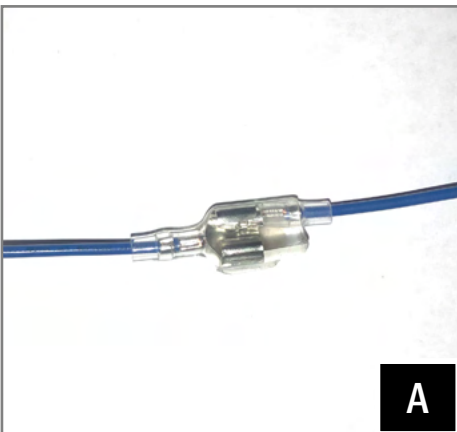

A. Connect the blue "AMP TURN-ON" from the MR1 power harness, to the blue, "AMP TURN-ON" on the 400.4 and 600.1 amplifiers.

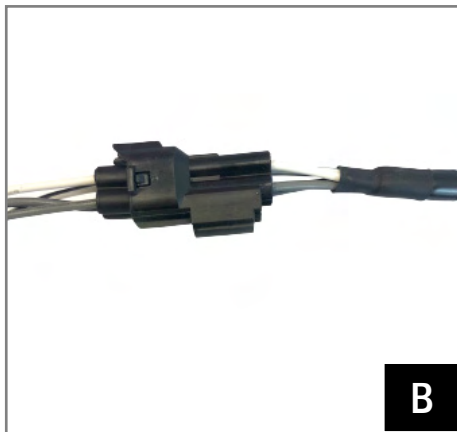

B. Connect the front (white/gray) output from the MR1 power harness to the front input of the 400.4 amp.

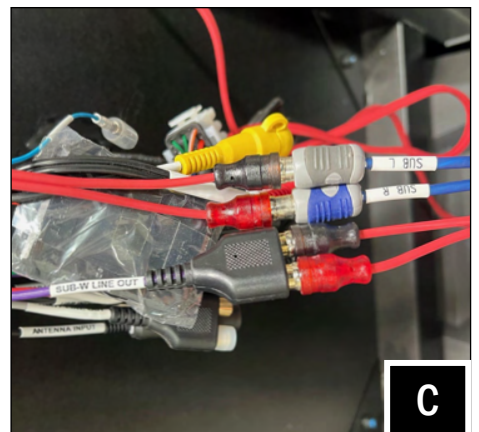

C. Connect the B-X3RCA patch cable between the Sub-W Line Out of the MR1 to the subwoofer L/R input of the 600.1 amp.

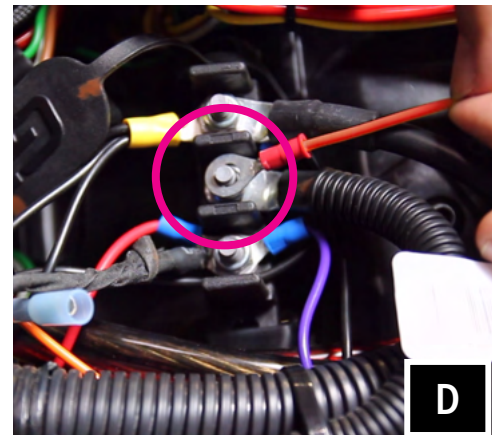
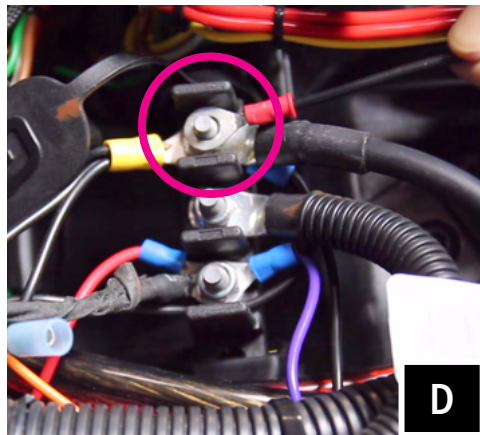
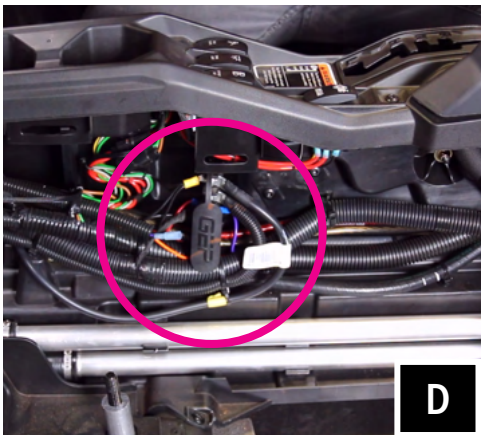

D. Connect the MR1 power and ground wires to the power strip located on the passenger side of the center console.

UNDER SEAT SUBWOOFER ENCLOSURE (DRIVER SIDE)

THIS STEP IS OPTIONAL

Some x3 models have a thinner skid plate than others and may rattle more. We have provided a drill template to help minimize skid plate rattle.

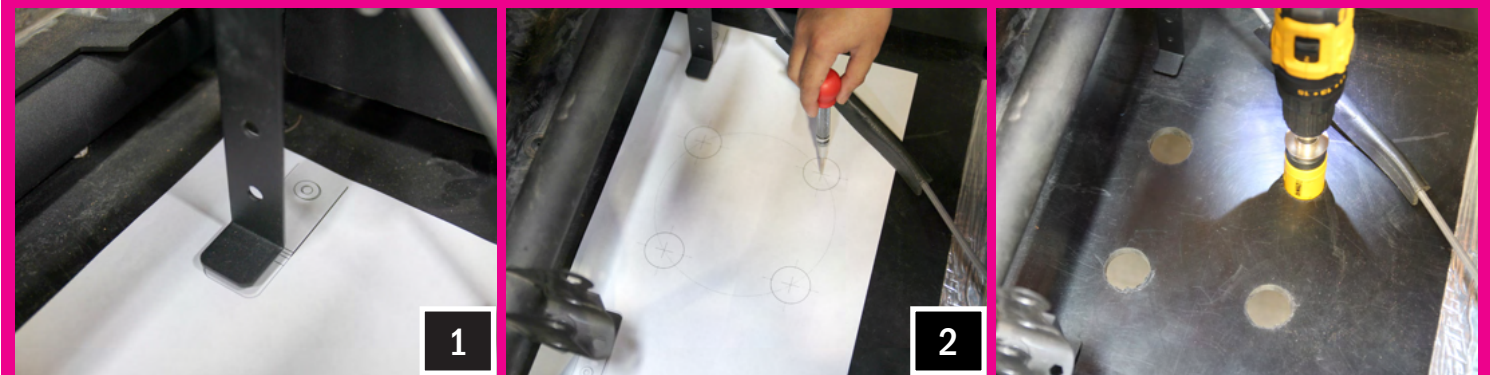

H. To help minimize skid plate rattle, we have supplied a drill template that adds 4 holes to help relieve air pressure that is being generated by the high output of the sub enclosure. Use the mounting bracket for the front of the sub enclosure for reference. Line up the template under the sub mounting brackets. (1). With hole punch/scribe tool mark the 4 drilling points through the template on to the floorboard (2). Drill the four (4) - 1½" holes with a hole saw (3).

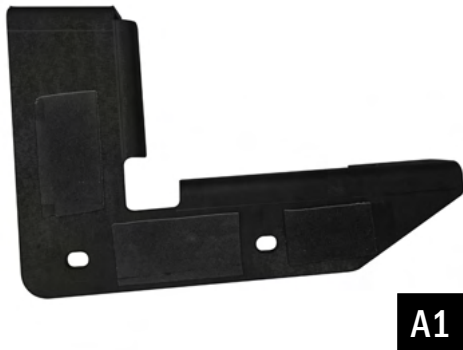

A1



A2

A. Apply the short foam strips to the large bracket in the order shown above (A1).
Apply the long foam strips to the outside edges of the enclosure. (Driver outside = left /
Passenger outside = right) (A2).



B. Using the supplied T-30 torx M6 screws and washers, screw the C bracket to the bottom left side of the enclosure.

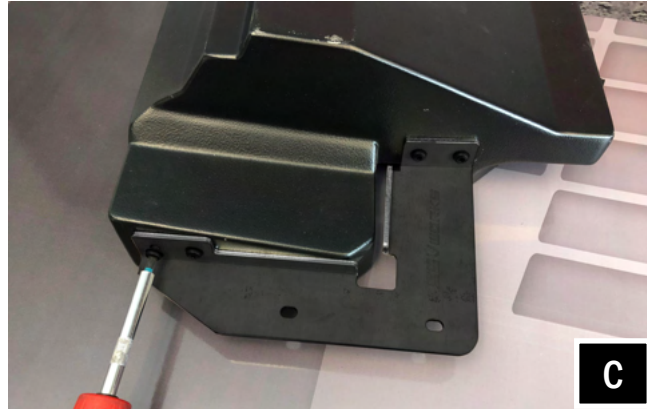

C. Using the supplied T-30 torx M6 screws and washers, screw the Large bracket to the right side of the enclosure shown above. Do not screw in all the way, leave the screws somewhat loose so that you can fit the enclosure snug and then tighten the screws after.

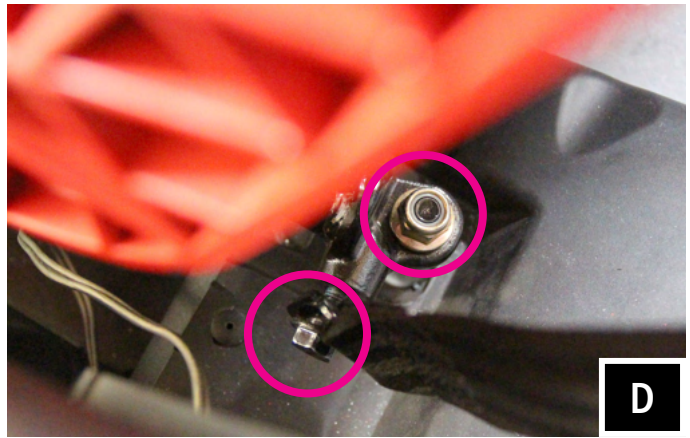

D. To remove driver the seat, use a 13mm socket and wrench to remove front (2) bolt and nut, and use a 18mm socket to remove (2) rear nuts and (1) 16mm seat belt bolt. Disconnect the seat belt sensor.



E. Remove the factory 10mm nut and bolt from the brake line. Place the washer on top of the factory bracket and push the long M6x25mm screw through the top. Then attach the brake line, spacer, washer and nut. (Disregard this step for the 4-seat Maverick X3 Max)

RGB CAGE POD WITH 6.5" SSV RGB SPEAKER



A. Find the best orientation for the speaker on your bar and screw in the Set Screws in the OPPOSITE holes of where the clamp will install into.



B. Loosely install the clamp base to the cage mount pod with the two (2) M6 hex head bolts and washers, place the cage mount pod in the desired mounting location on the vehicle. Once the ring adapter is in the desired position, tighten the two (2) bolts using a 8mm open wrench.



C. Place both ring mounting clamps on the cage using the plastic bag to prevent scratching, place the cage mount pod in its final mounting location and secure to the clamps using the two (2) M6 Allen socket head bolts and washers with a 5mm Allen key.

PLACEMENT OF THE POD DEPENDS ON WHAT TYPE OF ROLL CAGE YOU HAVE (FACTORY OR AFTERMARKET) AND YOUR PREFERENCE OF WHERE YOU WANT THE PODS TO BE INSTALLED. IN THESE INSTRUCTIONS, WE HAVE INSTALLED THEM ON THE OUTSIDE VERTICAL BARS AT THE BACK OF THE ROLL CAGE.



D. Position the speaker to your liking and tighten the hex head bolts by hand with a 8mm wrench.



D. Take the B-H2195 rear speaker harness and plug into the B-H1913 & B-H1912 rear extension harness.



E. Route the rear speaker harness along the factory wires in the engine compartment and pull up through the small space between the bed panel and cage tubing on both passenger and driver sides.



F. Route the rear speaker "Y" harness away from any moving parts and any sharp metal, then connect to the cage pods.



G. Connect the B-H1913 & B-H1912 speaker harness to the amplifier 800.5 rear output.

CONNECTING POWER & GROUND CABLE TO BATTERY



A. Unscrew the factory nut on the negative battery terminal. Install the 2 ground cables to the screw on the ground battery terminal. Re-install the factory nut.



B. Unscrew the factory nut on the positive battery terminal. Install the 2 power cables to the screw on the positive battery terminal. Re-install the factory nut.

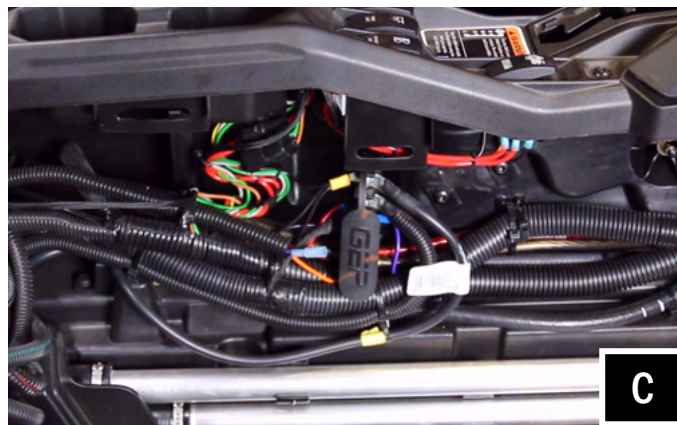

C. Zip tie all wiring to the factory cables away from any moving parts.

THIS CONCLUDES THE INSTALLATION PROCESS. REPLACE THE FACTORY PANELS AND SEATS. QUESTIONS? PLEASE CONTACT SSV WORKS AT 818-991-1778 OR EMAIL SUPPORT@SSVWORKS.COM



We are committed to your satisfaction and we know you will enjoy our products. If you have questions or need any assistance, please let us know.



-  [SSVWORKS.COM](https://www.ssvworks.com)
-  1-818-991-1778 EXT 2
-  SUPPORT@SSVWORKS.COM

Returns must be made within 30 days of purchase date. Claims for missing items or items damaged in transit must be received within five business days of receipt of merchandise. All returns must be in original packaging and in re-sellable condition. Shipping fees are not refundable.